

INSTALLATION AND OPERATING INSTRUCTIONS

LUX PSPH521 SERIES PROGRAMMABLE HEAT PUMP THERMOSTAT

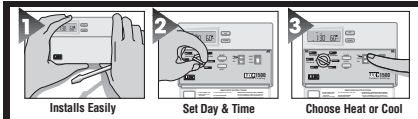

Easy as
1-2-3

Complete, Easy To Read Programming And Installation Instructions Inside

LUX PRODUCTS CORPORATION • Mt. Laurel, New Jersey 08054, USA 43343-04

WARNING: Use Energizer® or DURACELL® Alkaline Batteries Only.

Energizer® is a registered trademark of Eveready Battery Company, Inc.

DURACELL® is a registered trademark of The Gillette Company, Inc.

IMPORTANT!

READ INSTALLATION INSTRUCTIONS FIRST

Thank you for your confidence in our product. To obtain the best results from your investment, please read these instructions and acquaint yourself with your purchase before installing your new thermostat. Then follow the installation procedures, one step at a time. This will save you time and minimize the chance of damaging the thermostat and the systems it controls. These instructions may contain information beyond that required for your particular installation. Please save for future reference.

FEATURES

- The Unit can be used with most two stage heat and one stage cool heat pump systems.** It cannot be used with 120 volt heating systems. Ask your dealer for other LUX thermostats to control those systems.
- The Unit is programmable.** There are four programming periods per day. Each period can be programmed separately.
- You can use the built-in time/temperature programs, or alter them to suit your schedule.** The Unit provides separate programs for weekdays and weekends - for both heating and cooling. You can override the programmed temperatures for as little as one programming period or for an entire vacation.
- In cool weather,** when the system switch is set to HEAT, the Unit will maintain cooler "set back" room temperatures to save energy. It will then change to warmer "comfort" settings - all automatically, at specified times during the day.
- In warm weather,** when the system switch is set to COOL, the Unit will maintain warmer "set back" room temperatures to save energy. It will then change to cooler "comfort" settings - all automatically, at specified times during the day.
- A large liquid crystal display** shows time, day of the week, and room and set temperatures. It will remind you when the filter should be changed in your blower and track your system's energy usage.
- Temperature swing adjustment** lets you fine-tune your system for maximum comfort and economy.
- A 4-minute minimum on/off time** in COOL prevents your air conditioning system from being damaged.
- The thermostat can be powered either by a common wire from the 24Vac transformer with two Energizer® or DURACELL® "AA" size alkaline batteries as backup or exclusively by two Energizer® or DURACELL® "AA" size alkaline batteries.**

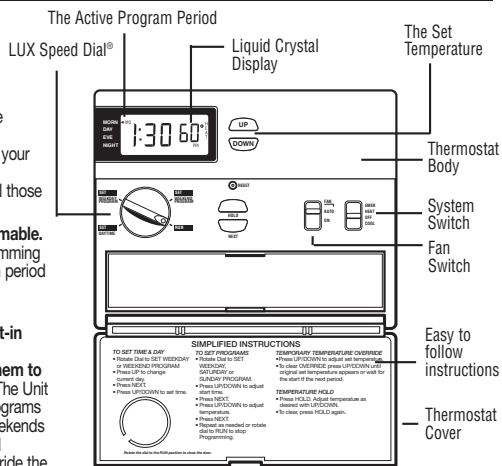

INSTALLATION

CAUTION

To avoid electrical shock and to prevent damage to the furnace, air conditioner, and thermostat, disconnect the power supply before beginning work. This can be done at the fuse box, at the circuit breaker, or at the appliance.

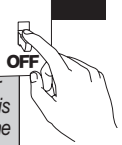

Please read all instructions carefully before beginning installation.

TOOLS REQUIRED

#1 Phillips screwdriver (small)

Drill with 3/16-in. (4.8mm) bit

THERMOSTAT LOCATION

On replacement installations, mount the new thermostat in place of the old one unless the conditions listed below suggest otherwise. On new installations, follow the guidelines listed below.

1. Locate the thermostat on an inside wall, about 5 ft. (1.5m) above the floor, and in a room that is used often.
2. Do not install it where there are unusual heating conditions, such as: in direct sunlight; near a lamp, radio, television, radiator, register, or fireplace; near hot water pipes in a wall; near a stove on the other side of a wall.
3. Do not locate in unusual cooling conditions, such as: on a wall separating an unheated room; or in a draft from a stairwell, door, or window.
4. Do not locate in a damp area. This can lead to corrosion that will shorten thermostat life.
5. Do not locate where air circulation is poor, such as: in a corner or an alcove; or behind an open door.
6. Do not install the unit until all construction work and painting has been completed.
7. This thermostat does not require leveling.

REMOVING THE OLD THERMOSTAT

Switch electricity to the furnace and air conditioner OFF; then proceed with the following steps.

1. Remove cover from old thermostat. Most are snap-on types and simply pull off. Some have locking screws on the side. These must be loosened.
2. Note the letters printed near the terminals. Attach labels (enclosed) to each wire for identification. Remove and label wires one at a time. Make sure the wires do not fall back inside the wall.
3. Loosen all screws on the old thermostat and remove it from the wall.

CAUTION

Read instructions carefully before removing any wiring from existing thermostat. Wires must be labeled before they are removed. When removing wires from their terminals, ignore the color of the wires since these may not comply with the standard.

MOUNTING THE UNIT ON THE WALL

1. Strip insulation 3/8 in. (9.5mm) from wire ends and clean off any corrosion.
2. Fill wall opening with non-combustible insulation to prevent drafts from affecting the thermostat.
3. Press up on the button on bottom of thermostat and swing the body away from the base and up to remove the body from the base.

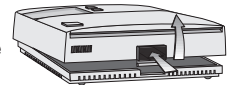

CAUTION

Be careful not to drop the body or disturb electronic parts. Leave the cover closed while the body is being removed from the base.

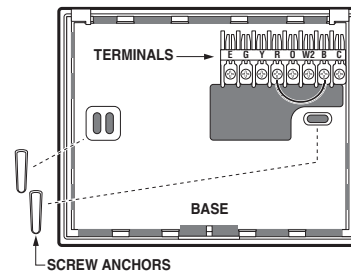

NOTE

If you are mounting the base to a soft material like plasterboard or if you are using the old mounting holes, the screws may not hold. Drill a 3/16-in. (4.8mm) hole at each screw location, and insert the plastic anchors provided. Then mount the base as described below.

Attaching Wires

4. Hold the base against the wall, with the wires coming through wherever it is convenient for wiring. Route the wires to below the terminal block. Position the base for best appearance (to hide any marks from an old thermostat). Attach the base to the wall with the two screws provided.



CAUTION

- Your thermostat is a precision instrument. Please handle it with care.
- Turn off electricity to the appliance before installing or servicing thermostat or any part of the system. Do not turn electricity back on until work is completed.
- Do not short (jumper) across electric terminals at control on furnace or air conditioner to test the system. This will damage the thermostat and void your warranty.
- All wiring must conform to local codes and ordinances.
- This thermostat is designed for use with 24 volt and millivolt systems. The thermostat should be limited to a maximum of 1.0 amps; higher amperage may cause damage to the thermostat. If you are in doubt, call your utility company.

C A U T I O N

Do not allow wires to touch each other or parts on thermostat. Wires must be trapped between black spacer and brass terminal. Also, be sure to tighten securely all terminal screws.

TERMINAL DESIGNATIONS

OLD TERMINAL DESIGNATIONS	NEW THERMOSTAT TERMINAL DESIGNATIONS	TYPICAL CONNECTION
B	B	Heating Changeover Valve
C, X, X1, X2, Z	C	Common
E, K	E	Emergency Heat Relay
G, F	G	Fan Relay
L, A, A1	TAPE OFF	Check Heat Pump Indicator
O	O	Cooling Changeover Valve
R, V	R	24V System or Heating Transformer
W2, H2, R4, W3, Y	W2	Stage 2 Heating Relay or Auxiliary Heat Relay
Y, C1, M, Y1	Y	Stage 1 Compressor Contractor

NOTE: A typical hookup will require either a "B" or "O" wire, but not both. If you have both a "B" and "O" wire, please call technical service.

TYPICAL HOOKUP

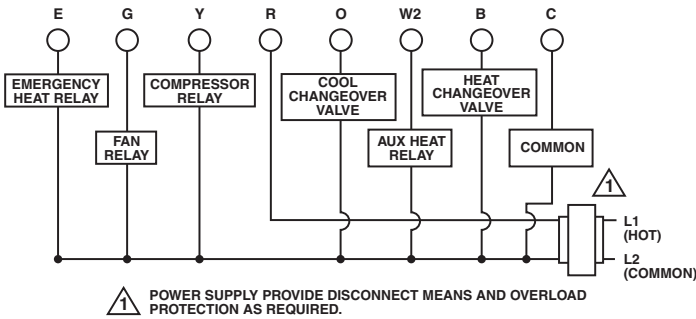

SETTING THE FAN AND SYSTEM SWITCHES

FAN ON	The fan runs continuously for increased air circulation.
FAN AUTO	Normal Setting. Fan is energized with the system.
EMER	Auxiliary heat is used for heating. The compressor is deenergized.
HEAT	The thermostat controls your heating.
OFF	Both heating and cooling are off.
COOL	The thermostat controls your cooling.

INSTALLING BATTERIES

The Unit requires batteries to retain its programming in memory. Replace the batteries when the REPLACE indicator appears in the display or at least once a year.

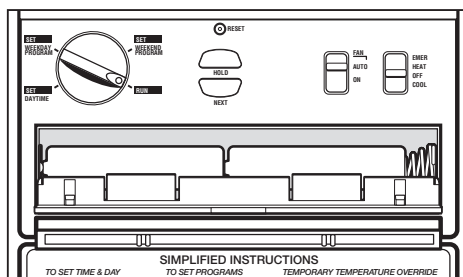

N O T E

When replacing batteries, you have approximately 1 minute before programs are lost.

DAY	LO BATT
EVE	
NIGHT	

REPLACE BATTERIES WHEN INDICATOR APPEARS

- Remove fresh batteries from their carton.
- Remove body of thermostat as described at bottom of first column.
- Remove the battery clip and batteries.
- Install two Energizer® or DURACELL® "AA" size alkaline batteries in the battery clip. Observe the polarity marking shown in the clip.

WARNING: Use Energizer® or DURACELL® Alkaline Batteries Only.

C A U T I O N

The Unit is protected against normal static electric discharges. However, in extremely dry weather you should touch another metal object before the Unit to avoid potential loss of programs.

- Place body back on the wall. Hook the bottom of the body onto the base, swing the body up, and snap the body onto the base.

Installation is now complete. Be sure to turn the power back on to your heating and /or air conditioning system. If this is the first time you are installing batteries, the thermostat will display "SUN 12:00 AM". Within 90 seconds the thermostat will begin to display the room temperature alternately with the time. To correct the display, see "Setting the TIME and DAY," after you set the programs.

O P E R A T I O N

This thermostat is "armchair programmable" You can make any program or setting changes with the thermostat body off or on the wall thermostat base.

The Unit alternately displays the current time and the room temperature. It also displays the day of the week and the currently active program period that is controlling the temperature: MORN, DAY, EVE, or NIGHT.

The set point temperature will appear in the right side of the display. In the winter, set the system switch to HEAT to control your heating system. In the summer, set the switch to COOL to control your air conditioner. In spring and fall or when windows are open, you can set the system switch OFF.

Setting the FAN switch to AUTO automatically runs your system's fan during heating and cooling. Setting the FAN switch to ON runs your system's fan continuously even without heating or cooling.

THE BUILT IN PROGRAMS

Push in the RESET key. This sets the built-in heating and cooling programs. To review the built-in programs, press NEXT or PREVIOUS repeatedly; when you are done, press RETURN.

You can use the built-in programs as shown, or change them as you wish. Each day is divided into four periods. Each period has its own starting time and temperature.

	PERIOD	HEAT	COOL
WEEKDAYS preprograms	MORN	6:00 AM 70°	6:00 AM 78°
	DAY	8:00 AM 62°	8:00 AM 85°
	EVE	6:00 PM 70°	6:00 PM 78°
	NIGHT	10:00 PM 62°	10:00 PM 82°
SAT & SUN preprograms	MORN	6:00 AM 70°	6:00 AM 78°
	DAY	8:00 AM 62°	8:00 AM 85°
	EVE	6:00 PM 70°	6:00 PM 78°
	NIGHT	10:00 PM 62°	10:00 PM 82°

P R O G R A M M I N G C H A R T

DAY	PERIOD	HEAT		COOL	
		TEMP.	TIME	TEMP.	TIME
MONDAY THROUGH FRIDAY	MORN				
	DAY				
	EVE				
	NIGHT				
SATURDAY AND SUNDAY	MORN				
	DAY				
	EVE				
	NIGHT				

PROGRAMMING THE UNIT



You can change any preset times and/or temperatures to suit your schedules for the weekday and weekend programs. Each period (Morning, Day, Evening, and Night) is programmed for HEAT and for COOL. A blank programming chart is provided for you to record your temperature settings in that chart.



N O T E
HEAT and COOL may have different temperatures.



 Select HEAT to program the thermostat for controlling your heater.
OR Select COOL to program the thermostat for controlling your air conditioner.







Rotate dial to SET WEEKDAY PROGRAM. To program the WEEKEND, rotate the dial to SET WEEKEND PROGRAM. With dial on set WEEKDAY Program, you will see this display.



 To change the start time for MORN.
 To program temperature.



 To change the start time for EVE.
 To program temperature.



 To change the temp. setting for MORN.
 To move to DAY.

 To change the temp. setting for EVE.
 To move to Night.

 To change start time for DAY.
 To program temperature.

 To change the start time for Night.
 To program temperature.

 To change the temp. setting for DAY.
 To move to eve.

 To change the temp. setting for Night.
 To move to eve.





Rotate dial to RUN position to start the programs or SET WEEKEND PROGRAM to continue programming.

SETTING THE TIME OF DAY



C A U T I O N
The unit is protected against normal static electric discharges. However, in extremely dry weather you should touch another metal object before the unit to avoid potential loss of programs.

Open the drop down door on the front of the thermostat. Rotate the dial to the SET DAY/TIME position. You should see the display pictured above with a day of the week flashing. When you are finished setting the day and time, rotate the dial to RUN to return to normal operation or to another position to continue programming.

 To change current day.
 To set current time. The time (e.g. "12:00 AM") will be flashing.
 To change the current time.
 To change the current time.

TEMPERATURE OVERRIDE AND TEMPERATURE HOLD

These features let you change the current Set Temperature without changing the programs stored in your thermostat's memory.

TEMPORARY TEMPERATURE OVERRIDE



Press UP/DOWN to change the current temperature setting. The OVERRIDE indicator appears on display. The Override feature will be automatically canceled at the start of the next program period. To cancel OVERRIDE prior to next program period press UP/DOWN until original set temperature appears. OVERRIDE indicator will disappear from display.

VACATION TEMPERATURE HOLD





Press HOLD. Adjust temperature as desired with UP/DOWN. Temperature setting will not change even after next program period begins. To clear, press HOLD again.

ADVANCED FEATURES



TEMPERATURE SWING

A thermostat works by turning your heating or cooling system on and off whenever the room temperature varies a certain number of degrees from the set-point temperature. This variation is the "swing."

Your system should cycle on about 3 to 6 times per hour. A smaller swing number increases the number of cycles, so room temperature is more constant. A larger swing number decreases the number of cycles, to save energy in most cases.



Dial must be in the run position

 Press together
 To change the temp. swing between 1-9 (4=approx. ±1°F)
 Press to set.

TEMPERATURE CALIBRATION



Rotate the dial to SET DAY/TIME

 Press together
 To adjust the thermostat

PROGRAM LOCK

To prevent tampering with set programs. The sequence of keys to lock and unlock the program:



N O T E
You must press "RESET" after enabling the features below. This will require you to reprogram your thermostat. Please copy your programs into the blank chart provided to assist reprogramming. Please reference the figure under "INSTALLING BATTERIES" which shows the JUMPER LOCATIONS

CHANGING FROM °F TO °C AND A 12HR CLOCK TO A 24HR CLOCK

WARNING: Making these changes will require you to reset the thermostat. Copy any of your customized programs onto the chart. This will be your reference to reenter the programs afterwards.

- To change to Celsius - remove jumper -J2.
- To change to a 24HR clock - remove jumper- J1.
- Press the reset key on the front of the thermostat for changes to take effect.
- Reprogram as necessary.

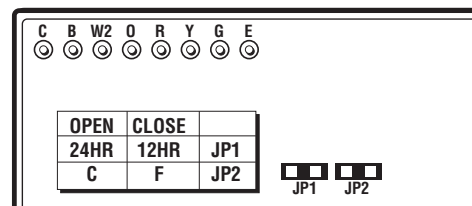

I M P O R T A N T
To protect your home from freezing in the event you have inadvertently left the unit switched OFF, or its batteries have been drained, your PSPH521 will energize the thermostat's heating terminals as necessary to control the temperature at approximately 40°F. Please call our technical assistance department if your application requires that this feature be disabled.

TECHNICAL SERVICE

If you have any problems installing or using this thermostat, please reread the instructions carefully. Technical Service is available through our Technical Service Number. If you require assistance, please call our offices between 8:00 a.m. and 4:30 p.m. Eastern Standard Time, Monday through Friday. The number is (856) 234-8803 or visit our online technical support at www.luxproproducts.com.

WARRANTY

Limited Warranty: If this unit fails because of defects in materials or workmanship within one year of date of original purchase, LUX will, at its option, repair or replace it. This warranty does not cover damage by accident, misuse, or failure to follow installation instructions. Implied warranties are limited in duration to one year from date of original purchase. Some states do not allow limitations on how long an implied warranty lasts, so the above limitation may not apply to you. Please return malfunctioning or defective units to the participating retailer from which purchase was made, along with proof of purchase. Please refer to Technical Service Section before returning thermostat.

Purchaser assumes all risks and liability for incidental and consequential damage resulting from installation and use of this unit. Some states do not allow the exclusion of incidental or consequential damages, so the above exclusion may not apply to you. This warranty gives you specific legal rights and you may also have other rights which vary from state to state. Applicable in the U.S.A. only.